

Pulegge trapezoidali per bussola conica / V-Belt pulleys for taper bushes Keilriemenscheiben für spannbuchsen / Poulies trapézoïdales à moyeu amovible Poleas trapezoidales para casquillos conicos

Le pulegge per cinghie trapezoidali presentate dalla S.A.T.I. nel presente catalogo sono tutte costruite secondo le tabelle ISO 4183 e DIN 2211-3.

V-belt pulleys proposed by S.A.T.I. in this catalogue are all manufactured according to ISO 4183 and DIN 2211-3 norms.

Die Keilriemenscheiben, die von S.A.T.I. in diesem Katalog dargestellt sind, sind alle nach ISO 4183 und DIN 2211-3 hergestellt worden.

Les poulies trapézoïdales présentées par la S.A.T.I. sur ce catalogue sont toutes fabriquées suivant les normes ISO 4183 et DIN 2211-3.

Las poleas para correas trapezoidales presentadas por la S.A.T.I. en el presente catálogo están todas construidas según las tablas ISO 4183 y DIN 2211-3.

Il materiale impiegato nella costruzione delle medesime è in ghisa EN-GJL-200 UNI EN 1561 e, successivamente alle lavorazioni meccaniche, subiscono un trattamento superficiale di FOSFATAZIONE.

The material used for the construction of these pulleys is cast iron EN-GJL-200 UNI EN 1561 and after the machining all pulleys are being PHOSPHATED.

Das fuer die Produktion verwendete Material ist Grauguss EN-GJL-200 UNI EN 1561 und nach der Bearbeitung werden alle Keilriemenscheiben PHOSPHATIERT.

Le materiel utilisé pour la fabrication des poulies est la fonte EN-GJL-200 UNI EN 1561 et après l'usinage elles sont toutes exposées à un traitement de PHOSPHATATION.

El material empleado en la construcción de las mismas es el hierro fundido EN-GJL-200 UNI EN 1561 y después de las elaboraciones mecánicas están sometidas a un tratamiento superficial de FOSFATACIÓN.

Tutte le pulegge sono equilibrate STATICAMENTE ed idonee ad un funzionamento fino alla velocità periferica di 35 m/s.

All pulleys are STATICALLY balanced and suitable for peripheral speed up to 35 m/s.

Alle Keilriemenscheiben sind STATISCH ausgewuchtet und fuer eine peripherische Betriebsgeschwindigkeit bis 35 m/s.

Toutes les poulies sont équilibrées STATIQUEMENT et propres à tourner à une vitesse périphérique jusqu'à 35 m/s.

Todas las poleas están equilibradas ESTÁTICAMENTE y son adecuadas para un funcionamiento de una velocidad de hasta 35 m/s.

La gamma proposta nel seguente catalogo, comprende: PULEGGE TRAPEZOIDALI, per bussola conica, serie ZT..... AT..... BT..... CT..... PULEGGE TRAPEZOIDALI monoblocco (con mozzo pieno) serie ZM..... AM..... BM..... CM..... PULEGGE TRAPEZOIDALI per calettatore.

The range proposed in this catalogue is the following: V-BELT PULLEYS for taper bush, series ZT..... AT..... BT..... CT..... V-BELT PULLEYS with solid hub, series ZM..... AM..... BM..... CM..... V-BELT PULLEYS for locking devices.

Die in diesem Katalog angegebene Palette ist die folgende: KEILRIEMENSCHLEIBEN fuer Spannbuchse, Serie ZT..... AT..... BT..... CT..... KEILRIEMENSCHLEIBEN ungebohrt, Serie ZM..... AM..... BM..... CM..... KEILRIEMENSCHLEIBEN fuer Spannsätze.

La gamme proposée dans ce catalogue est la suivante: POULIES TRAPEZOIDALES pour moyeu amovible, série ZT..... AT..... BT..... CT..... POULIES TRAPEZOIDALES à moyeu plein, série ZM..... AM..... BM..... CM..... POULIES TRAPEZOIDALES pour moyeu de serrage.

La gama propuesta en el siguiente catálogo comprende: POLEAS TRAPEZOIDALES para casquillos cónicos, serie ZT..... AT..... BT..... CT..... POLEAS TRAPEZOIDALES con cubo pleno, serie ZM..... AM..... BM..... CM..... POLEAS TRAPEZOIDALES para casquillos de fijación.

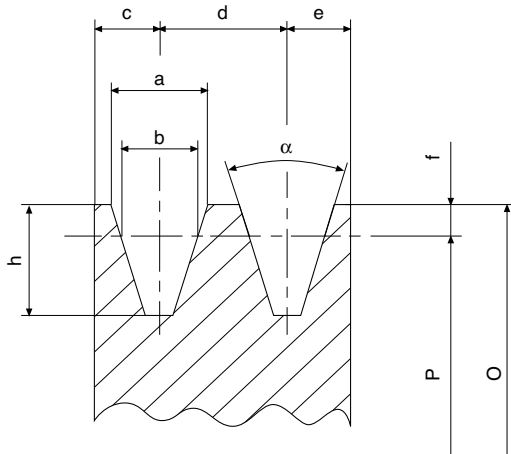

Calcolo della velocità periferica V_p in m/s
Calculation of peripheral speed V_p in m/s
Berechnung der Umfangsgeschwindigkeit V_p in m/s
Calcul de la vitesse périphérique V_p m/s
Cálculo de la velocidad periférica V_p en m/s

$$V_p = \frac{\pi \cdot P \cdot \text{rpm}}{60 \cdot 1000} \cong \frac{P \cdot \text{rpm}}{19100} \quad V_p \leq 35 \text{ m/s}$$

P = Diametro primitivo in mm
Pitch diameter in mm
Teildurchmesser in mm
Diamètre primitif en mm
Diámetro primitivo en mm

rpm = Giri al minuto
Revolutions per minute
Umdrehungen pro Minute
Tours par minute
Revoluciones por minuto

Dimensioni puleggia / Pulley dimensions / Keilriemenscheibeabmessungen / Dimensions poulie / Dimensiones polea

	a	b	c	d	e	f	h	34°	38°
SPZ	9,7	8,5	8,0	12,0	8,0	2,0	11,0	P ≤ 80	P > 80
SPA	12,7	11,0	10,0	15,0	10,0	2,8	13,8	P ≤ 118	P > 118
SPB	16,3	14,0	12,5	19,0	12,5	3,5	17,5	P ≤ 190	P > 190
SPC	22,0	19,0	17,0	25,5	17,0	4,8	23,8	P ≤ 315	P > 315

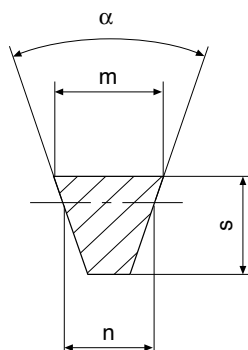

Dimensioni cinghia / Belt dimensions / Riemenabmessungen / Dimensions courroie / Dimensiones correa

	m	s	n
SPZ	9,7	8	8,5
SPA	12,7	10	11,0
SPB	16,3	13	14,0
SPC	22,0	18	19,0

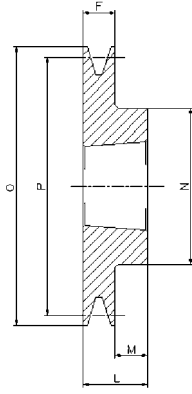

1

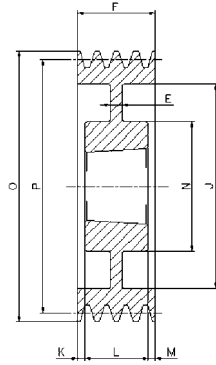

6

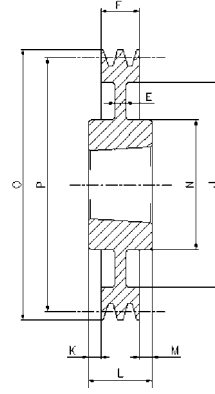

7

SPB/1

Cod. interno Internal code Innerer Code Code interne Código interno	Tipo Type Typ Type Tipo	Gole Grooves Rillen Gorges Canales	P	O	Forma Form Forme Forme Forma	Bussola Bush Buchse Moyeu Casquillo	Ø MAX	E	F	J	K	L	M	N
BT01001	SPB100-01	1	100	107	1	1610	42	-	25	-	-	25	-	-
BT01061	SPB106-1	1	106	113	1	1610	42	-	25	-	-	25	-	-
BT01121	SPB112-01	1	112	119	1	1610	42	-	25	-	-	25	-	-
BT01181	SPB118-01	1	118	125	1	1610	42	-	25	-	-	25	-	-
BT01251	SPB125-01	1	125	132	1	1610	42	-	25	-	-	25	-	-
BT01321	SPB132-01	1	132	139	1	1610	42	-	25	-	-	25	-	-
BT01401	SPB140-01	1	140	147	1	1610	42	-	25	-	-	25	-	-
BT01501	SPB150-01	1	150	157	1	1610	42	-	25	-	-	25	-	-
BT01601	SPB160-01	1	160	167	1	1610	42	-	25	-	-	25	-	-
BT01701	SPB170-01	1	170	177	1	1610	42	-	25	-	-	25	-	-
BT01801	SPB180-01	1	180	187	6	1610	42	15	25	132	-	25	-	90
BT01901	SPB190-01	1	190	197	7	2012	50	15	25	147	3,5	32	3,5	104
BT02001	SPB200-01	1	200	207	7	2012	50	15	25	157	3,5	32	3,5	104
BT02121	SPB212-01	1	212	219	7	2012	50	15	25	169	3,5	32	3,5	104
BT02241	SPB224-01	1	224	231	7	2012	50	15	25	181	3,5	32	3,5	104
BT02361	SPB236-01	1	236	243	7	2012	50	15	25	193	3,5	32	3,5	104
BT02501	SPB250-01	1	250	257	7	2012	50	20	25	207	3,5	32	3,5	104
BT02801	SPB280-01	1	280	287	7	2012	50	20	25	237	3,5	32	3,5	104
BT03001	SPB300-01	1	300	307	7	2012	50	20	25	258	3,5	32	3,5	104
BT03151	SPB315-01	1	315	322	7	2012	50	20	25	272	3,5	32	3,5	104

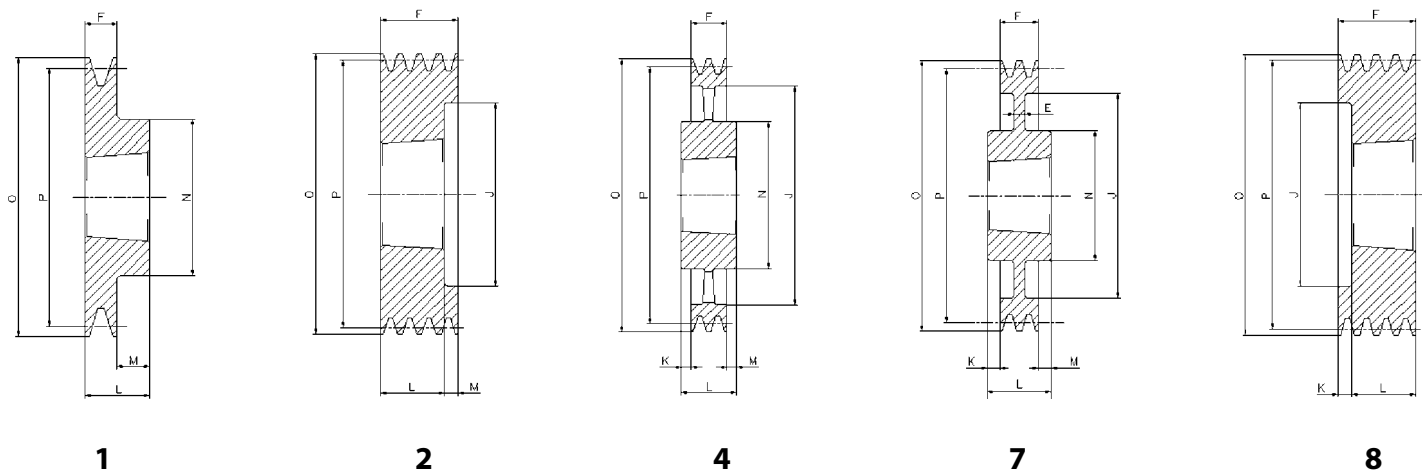

SPB/2

Cod. interno Internal code Innerer Code Code interne Código interno	Tipo Type Typ Type Tipo	Gole Grooves Rillen Gorges Canales	P	O	Forma Form Forme Forme Forma	Bussola Bush Buchse Moyeu Casquillo	Ø MAX	E	F	J	K	L	M	N
BT01002	SPB100-02	2	100	107	8	1610	42	-	44	62	19,0	25	-	-
BT01062	SPB106-02	2	106	113	8	1610	42	-	44	67	19,0	25	-	-
BT01122	SPB112-02	2	112	119	8	1610	42	-	44	72	19,0	25	-	-
BT01182	SPB118-02	2	118	125	2	1610	42	-	44	78	-	25	19,0	-
BT01252	SPB125-02	2	125	132	2	2012	50	-	44	82	-	32	12,0	-
BT01322	SPB132-02	2	132	139	2	2012	50	-	44	89	-	32	12,0	-
BT01402	SPB140-02	2	140	147	2	2012	50	-	44	97	-	32	12,0	-
BT01502	SPB150-02	2	150	157	2	2012	50	-	44	107	-	32	12,0	-
BT01602	SPB160-02	2	160	167	2	2012	50	-	44	117	-	32	12,0	-
BT01702	SPB170-02	2	170	177	2	2012	50	-	44	127	-	32	12,0	-
BT01802	SPB180-02	2	180	187	1	2517	60	-	44	-	-	45	1,0	120
BT01902	SPB190-02	2	190	197	1	2517	60	-	44	-	-	45	1,0	120
BT02002	SPB200-02	2	200	207	1	2517	60	-	44	-	-	45	1,0	117
BT02122	SPB212-02	2	212	219	7	2517	60	20	44	169	-	45	1,0	117
BT02242	SPB224-02	2	224	231	7	2517	60	15	44	181	-	45	1,0	117
BT02362	SPB236-02	2	236	243	7	2517	60	15	44	193	-	45	1,0	117
BT02502	SPB250-02	2	250	257	7	2517	60	20	44	207	-	45	1,0	125
BT02802	SPB280-02	2	280	287	7	2517	60	20	44	237	-	45	1,0	125
BT03002	SPB300-02	2	300	307	7	2517	60	20	44	257	-	45	1,0	125
BT03152	SPB315-02	2	315	322	7	2517	60	20	44	272	-	45	1,0	125
BT03352	SPB335-02	2	335	342	7	2517	60	20	44	292	-	45	1,0	125
BT03552	SPB355-02	2	355	362	7	3020	75	15	44	312	3,5	51	3,5	144
BT04002	SPB400-02	2	400	407	4	3020	75	-	44	357	3,5	51	3,5	150
BT04502	SPB450-02	2	450	457	4	3020	75	-	44	407	3,5	51	3,5	150
BT05002	SPB500-02	2	500	507	4	3020	75	-	44	457	3,5	51	3,5	150
BT05602	SPB560-02	2	560	567	4	3030	75	-	44	517	4,0	76	28,0	150
BT06302	SPB630-02	2	630	637	4	3030	75	-	44	587	16,0	76	16,0	150

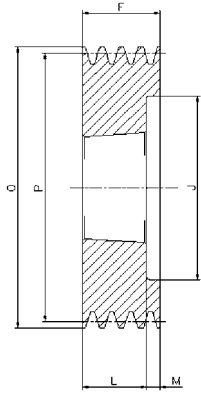

2

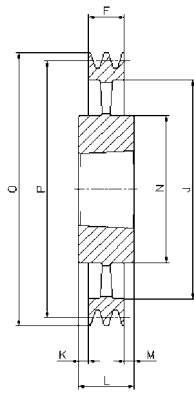

4

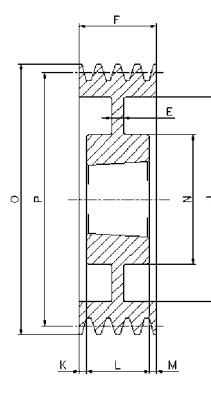

6

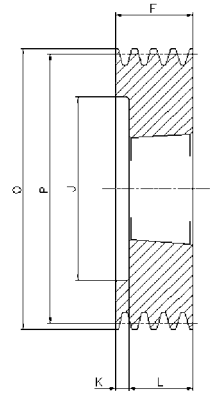

8

SPB/3

Cod. interno Internal code Innerer Code Code interne Código interno	Tipo Type Typ Type Tipo	Gole Grooves Rillen Gorges Canales	P	O	Forma Form Forme Forme Forma	Bussola Bush Buchse Moyeu Casquillo	∅ MAX	E	F	J	K	L	M	N
BT01003	SPB100-03	3	100	107	8	1610	42	-	63	62	38,0	25	-	-
BT01063	SPB106-03	3	106	113	8	1610	42	-	63	67	38,0	25	-	-
BT01123	SPB112-03	3	112	119	8	1610	42	-	63	72	38,0	25	-	-
BT01183	SPB118-03	3	118	125	2	1610	42	-	63	78	-	25	38,0	-
BT01253	SPB125-03	3	125	132	2	2012	50	-	63	82	-	32	31,0	-
BT01323	SPB132-03	3	132	139	2	2012	50	-	63	89	-	32	31,0	-
BT01403	SPB140-03	3	140	147	2	2012	50	-	63	97	-	32	31,0	-
BT01503	SPB150-03	3	150	157	2	2517	60	-	63	107	-	45	18,0	-
BT01603	SPB160-03	3	160	167	2	2517	60	-	63	117	-	45	18,0	-
BT01703	SPB170-03	3	170	177	2	2517	60	-	63	127	-	45	18,0	-
BT01803	SPB180-03	3	180	187	2	2517	60	-	63	137	-	45	18,0	-
BT01903	SPB190-03	3	190	197	2	2517	60	-	63	147	-	45	18,0	-
BT02003	SPB200-03	3	200	207	2	2517	60	-	63	157	-	45	18,0	-
BT02123	SPB212-03	3	212	219	6	2517	60	15	63	169	-	45	18,0	117
BT02243	SPB224-03	3	224	231	6	2517	60	15	63	181	-	45	18,0	117
BT02363	SPB236-03	3	236	243	6	2517	60	15	63	193	-	45	18,0	117
BT02503	SPB250-03	3	250	257	6	3020	75	20	63	207	-	51	12,0	144
BT02803	SPB280-03	3	280	287	6	3020	75	20	63	237	6,0	51	6,0	144
BT03003	SPB300-03	3	300	307	6	3020	75	20	63	257	6,0	51	6,0	144
BT03153	SPB315-03	3	315	322	6	3020	75	20	63	272	6,0	51	6,0	144
BT03353	SPB335-03	3	335	342	6	3020	75	20	63	292	6,0	51	6,0	144
BT03553	SPB355-03	3	355	362	6	3020	75	15	63	312	6,0	51	6,0	144
BT04003	SPB400-03	3	400	407	4	3535	90	-	63	357	13,0	89	13,0	175
BT04503	SPB450-03	3	450	457	4	3535	90	-	63	407	-	89	26,0	175
BT05003	SPB500-03	3	500	507	4	3535	90	-	63	457	-	89	26,0	175
BT05603	SPB560-03	3	560	567	4	3535	90	-	63	517	-	89	26,0	175
BT06303	SPB630-03	3	630	637	4	3535	90	-	63	587	-	89	26,0	175
BT07103	SPB710-03	3	710	717	4	3535	90	-	63	664	13,0	89	13,0	175
BT08003	SPB800-03	3	800	807	4	3535	90	-	63	754	13,0	89	13,0	175
BT09003	SPB900-03	3	900	907	4	3535	90	-	63	854	13,0	89	13,0	175
BT10003	SPB1000-03	3	1000	1007	4	4040	100	-	63	954	19,5	102	19,5	210
BT12503	SPB1250-03	3	1250	1257	4	4040	100	-	63	1204	19,5	102	19,5	210

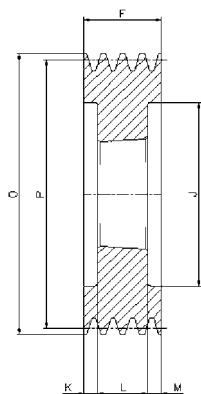

3

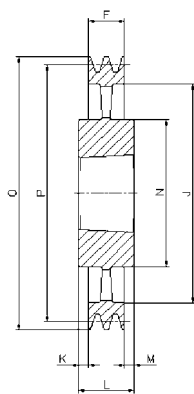

4

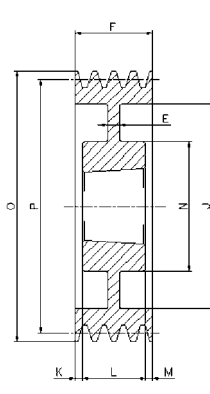

6

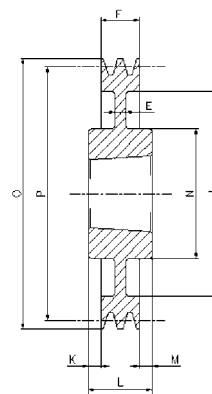

7

SPB/4

Cod. interno Internal code Innerer Code Code interne Código interno	Tipo Type Typ Type Tipo	Gole Grooves Rillen Gorges Canales	P	O	Forma Form Forme Forme Forma	Bussola Bush Buchse Moyeu Casquillo	∅ MAX	E	F	J	K	L	M	N
BT01004	SPB100-04	4	100	117	8	1615	42	-	82	60	44,0	38	-	-
BT01124	SPB112-04	4	112	119	8	2012	42	-	82	72	50,0	32	-	-
BT01254	SPB125-04	4	125	132	3	2012	50	-	82	82	25,0	32	25,0	-
BT01324	SPB132-04	4	132	139	3	2012	50	-	82	89	25,0	32	25,0	-
BT01404	SPB140-04	4	140	147	3	2517	60	-	82	100	18,5	45	18,5	-
BT01504	SPB150-04	4	150	157	3	2517	60	-	82	107	18,5	45	18,5	-
BT01604	SPB160-04	4	160	167	3	2517	60	-	82	117	18,5	45	18,5	-
BT01704	SPB170-04	4	170	177	3	2517	60	-	82	127	18,5	45	18,5	-
BT01804	SPB180-04	4	180	187	3	2517	60	-	82	137	18,5	45	18,5	-
BT01904	SPB190-04	4	190	197	3	2517	60	-	82	147	18,5	45	18,5	-
BT02004	SPB200-04	4	200	207	3	3020	75	-	82	157	15,5	51	15,5	-
BT02124	SPB212-04	4	212	219	3	3020	75	-	82	169	15,5	51	15,5	-
BT02244	SPB224-04	4	224	231	3	3020	75	-	82	181	15,5	51	15,5	-
BT02364	SPB236-04	4	236	243	3	3020	75	-	82	193	15,5	51	15,5	-
BT02504	SPB250-04	4	250	257	6	3020	75	25	82	207	15,5	51	15,5	144
BT02804	SPB280-04	4	280	287	6	3020	75	25	82	237	15,5	51	15,5	144
BT03004	SPB300-04	4	300	307	7	3535	90	25	82	257	-	89	7,0	175
BT03154	SPB315-04	4	315	322	7	3535	90	25	82	272	3,5	89	3,5	175
BT03354	SPB335-04	4	335	342	7	3535	90	25	82	292	3,5	89	3,5	175
BT03554	SPB355-04	4	355	362	7	3535	90	25	82	312	3,5	89	3,5	175
BT04004	SPB400-04	4	400	407	4	3535	90	-	82	357	3,5	89	3,5	175
BT04504	SPB450-04	4	450	457	4	3535	90	-	82	407	-	89	7,0	175
BT05004	SPB500-04	4	500	507	4	3535	90	-	82	457	-	89	7,0	175
BT05604	SPB560-04	4	560	567	4	3535	90	-	82	517	-	89	7,0	175
BT06304	SPB630-04	4	630	637	4	3535	90	-	82	587	-	89	7,0	175
BT07104	SPB710-04	4	710	717	4	3535	90	-	82	664	3,5	89	3,5	175
BT08004	SPB800-04	4	800	807	4	4040	100	-	82	754	10,0	102	10,0	210
BT09004	SPB900-04	4	900	907	4	4040	100	-	82	854	10,0	102	10,0	210
BT10004	SPB1000-04	4	1000	1007	4	4040	100	-	82	954	10,0	102	16,0	210
BT12504	SPB1250-04	4	1250	1257	4	4545	110	-	82	1204	16,0	114	16,0	210

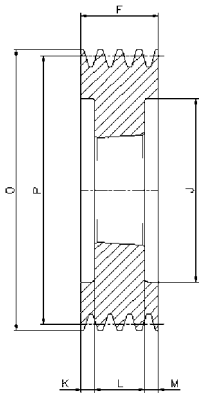

3

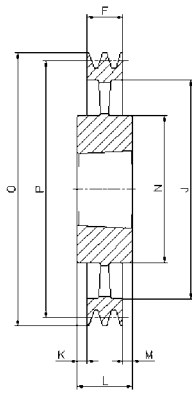

4

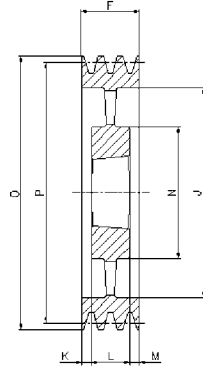

5

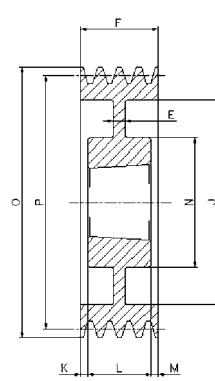

6

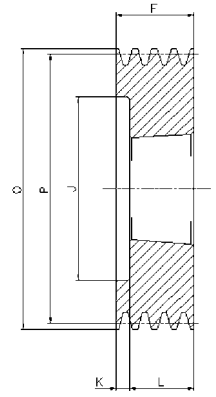

8

SPB/5

Cod. interno Internal code Code interne Código interno	Tipo Type Typ Type Tipo	Gole Grooves Rillen Gorges Canales	P	O	Forma Form Forme Forme Forma	Bussola Bush Buchse Moyeu Casquillo	∅ MAX	E	F	J	K	L	M	N
BT01255	SPB125-05	5	125	132	8	2012	50	-	101	87	69,0	32	-	-
BT01325	SPB132-05	5	132	139	8	2517	60	-	101	94	56,0	45	-	-
BT01405	SPB140-05	5	140	147	3	2517	60	-	101	97	28,0	45	28,0	-
BT01505	SPB150-05	5	150	157	3	2517	60	-	101	107	28,0	45	28,0	-
BT01605	SPB160-05	5	160	167	3	2517	60	-	101	117	28,0	45	28,0	-
BT01705	SPB170-05	5	170	177	3	3020	75	-	101	127	25,0	51	25,0	-
BT01805	SPB180-05	5	180	187	3	3020	75	-	101	137	25,0	51	25,0	-
BT01905	SPB190-05	5	190	197	3	3020	75	-	101	147	25,0	51	25,0	-
BT02005	SPB200-05	5	200	207	3	3020	75	-	101	157	25,0	51	25,0	-
BT02125	SPB212-05	5	212	219	3	3020	75	-	101	169	25,0	51	25,0	-
BT02245	SPB224-05	5	224	231	3	3020	75	-	101	181	25,0	51	25,0	-
BT02365	SPB236-05	5	236	243	3	3535	90	-	101	193	6,0	89	6,0	-
BT02505	SPB250-05	5	250	257	3	3535	90	-	101	207	6,0	89	6,0	-
BT02805	SPB280-05	5	280	287	6	3535	90	25	101	237	6,0	89	6,0	175
BT03005	SPB300-05	5	300	307	6	3535	90	25	101	257	6,0	89	6,0	175
BT03155	SPB315-05	5	315	322	6	3535	90	25	101	272	6,0	89	6,0	175
BT03355	SPB335-05	5	335	342	6	3535	90	25	101	292	6,0	89	6,0	175
BT03555	SPB355-05	5	355	362	6	3535	90	17	101	312	6,0	89	6,0	175
BT04005	SPB400-05	5	400	407	5	3535	90	-	101	357	6,0	89	6,0	175
BT04505	SPB450-05	5	450	457	5	3535	90	-	101	407	-	89	12,0	175
BT05005	SPB500-05	5	500	507	5	3535	90	-	101	457	-	89	12,0	175
BT05605	SPB560-05	5	560	567	4	4040	100	-	101	517	-	102	1,0	210
BT06305	SPB630-05	5	630	637	4	4040	100	-	101	587	-	102	1,0	210
BT07105	SPB710-05	5	710	717	4	4040	100	-	101	664	-	102	1,0	210
BT08005	SPB800-05	5	800	807	4	4040	100	-	101	754	-	102	1,0	210
BT09005	SPB900-05	5	900	907	4	4040	100	-	101	854	-	102	1,0	210
BT10005	SPB1000-05	5	1000	1007	4	4545	110	-	101	954	6,5	114	6,5	242
BT12505	SPB1250-05	5	1250	1257	4	4545	110	-	101	1204	6,5	114	6,5	242

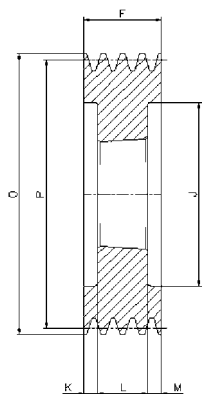

3

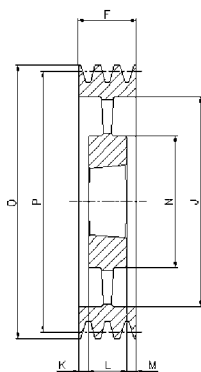

5

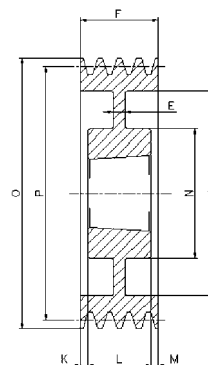

6

SPB/6

Cod. interno Internal code Inner Code Code interne Código interno	Tipo Type Typ Type Tipo	Gole Grooves Rillen Gorges Canales	P	O	Forma Forme Forme Forme Forma	Bussola Bush Buchse Moyeu Casquillo	∅ MAX	E	F	J	K	L	M	N
BT01406	SPB140-06	6	140	147	3	2517	60	-	120	100	37,5	45	37,5	-
BT01506	SPB150-06	6	150	157	3	2517	60	-	120	107	37,5	45	37,5	-
BT01606	SPB160-06	6	160	167	3	3020	75	-	120	117	34,5	51	34,5	-
BT01706	SPB170-06	6	170	177	3	3020	75	-	120	127	34,5	51	34,5	-
BT01806	SPB180-06	6	180	187	3	3020	75	-	120	137	34,5	51	34,5	-
BT01906	SPB190-06	6	190	197	3	3020	75	-	120	147	34,5	51	34,5	-
BT02006	SPB200-06	6	200	207	3	3020	75	-	120	157	34,5	51	34,5	-
BT02126	SPB212-06	6	212	219	3	3535	90	-	120	169	15,5	89	15,5	-
BT02246	SPB224-06	6	224	231	3	3535	90	-	120	181	15,5	89	15,5	-
BT02366	SPB236-06	6	236	243	3	3535	90	-	120	193	15,5	89	15,5	-
BT02506	SPB250-06	6	250	257	3	3535	90	-	120	207	15,5	89	15,5	-
BT02806	SPB280-06	6	280	287	6	3535	90	25	120	237	15,5	89	15,5	175
BT03006	SPB300-06	6	300	307	6	3535	90	25	120	257	15,5	89	15,5	175
BT03156	SPB315-06	6	315	322	6	3535	90	25	120	272	15,5	89	15,5	175
BT03356	SPB335-06	6	335	342	6	3535	90	25	120	292	15,5	89	15,5	175
BT03556	SPB355-06	6	355	362	6	3535	90	25	120	312	15,5	89	15,5	175
BT04006	SPB400-06	6	400	407	5	3535	90	-	120	357	15,5	89	15,5	175
BT04506	SPB450-06	6	450	457	5	4040	100	-	120	407	-	102	18,0	210
BT05006	SPB500-06	6	500	507	5	4040	100	-	120	457	-	102	18,0	210
BT05606	SPB560-06	6	560	567	5	4040	100	-	120	517	-	102	18,0	210
BT06306	SPB630-06	6	630	637	5	4040	100	-	120	587	-	102	18,0	210
BT07106	SPB710-06	6	710	717	5	4040	100	-	120	664	9,0	102	9,0	210
BT08006	SPB800-06	6	800	807	5	4545	110	-	120	754	3,0	114	3,0	242
BT09006	SPB900-06	6	900	907	5	4545	110	-	120	854	3,0	114	3,0	242
BT10006	SPB1000-06	6	1000	1007	5	4545	110	-	120	954	3,0	114	3,0	242
BT12506	SPB1250-06	6	1250	1257	5	4545	110	-	120	1204	3,0	114	3,0	242

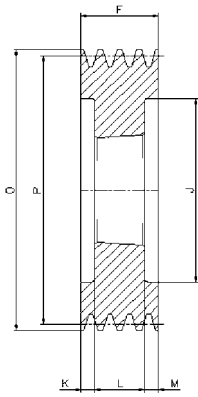

3

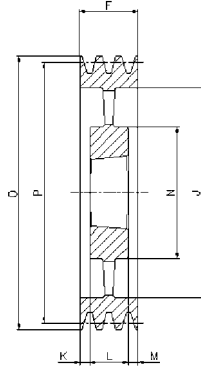

5

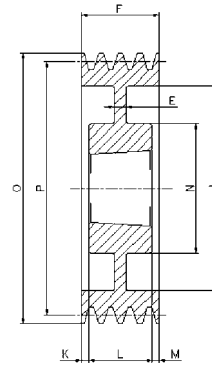

6

SPB/8

Cod. interno Internal code Innerer Code Code interne Código interno	Tipo Type Typ Type Tipo	Gole Grooves Rillen Gorges Canales	P	O	Forma Form Forme Forme Forma	Bussola Bush Buchse Moyeu Casquillo	Ø MAX	E	F	J	K	L	M	N
BT01408	SPB140-08	8	140	147	3	2517	60	-	158	97	56,5	45	56,5	-
BT01608	SPB160-08	8	160	167	3	3020	75	-	158	117	53,5	51	53,5	-
BT01708	SPB170-08	8	170	177	3	3030	75	-	158	127	41,0	76	41,0	-
BT01808	SPB180-08	8	180	187	3	3030	75	-	158	137	41,0	76	41,0	-
BT01908	SPB190-08	8	190	197	3	3030	75	-	158	147	41,0	76	41,0	-
BT02008	SPB200-08	8	200	207	3	3535	90	-	158	157	34,5	89	34,5	-
BT02128	SPB212-08	8	212	219	3	3535	90	-	158	169	34,5	89	34,5	-
BT02248	SPB224-08	8	224	231	3	3535	90	-	158	181	34,5	89	34,5	-
BT02368	SPB236-08	8	236	243	3	3535	90	-	158	193	34,5	89	34,5	-
BT02508	SPB250-08	8	250	257	3	3535	90	-	158	207	34,5	89	34,5	-
BT02808	SPB280-08	8	280	287	6	3535	90	25	158	237	34,5	89	34,5	175
BT03008	SPB300-08	8	300	307	6	3535	90	25	158	257	34,5	89	34,5	175
BT03158	SPB315-08	8	315	322	6	3535	90	25	158	272	34,5	89	34,5	175
BT03358	SPB335-08	8	335	342	6	3535	90	25	158	292	34,5	89	34,5	175
BT03558	SPB355-08	8	355	362	6	3535	90	25	158	312	34,5	89	34,5	175
BT04008	SPB400-08	8	400	407	6	4040	100	30	158	357	28,0	102	28,0	210
BT04508	SPB450-08	8	450	457	5	4040	100	-	158	407	28,0	102	28,0	210
BT05008	SPB500-08	8	500	507	5	4040	100	-	158	457	28,0	102	28,0	210
BT05608	SPB560-08	8	560	567	5	4545	110	-	158	517	22,0	114	22,0	242
BT06308	SPB630-08	8	630	637	5	4545	110	-	158	587	22,0	114	22,0	242
BT07108	SPB710-08	8	710	717	5	4545	110	-	158	664	22,0	114	22,0	242
BT08008	SPB800-08	8	800	807	5	4545	110	-	158	754	22,0	114	22,0	242
BT09008	SPB900-08	8	900	907	5	4545	110	-	158	854	22,0	114	22,0	242
BT10008	SPB1000-08	8	1000	1007	5	5050	125	-	158	954	15,5	127	15,5	267
BT12508	SPB1250-08	8	1250	1257	5	5050	125	-	158	1204	15,5	127	15,5	267

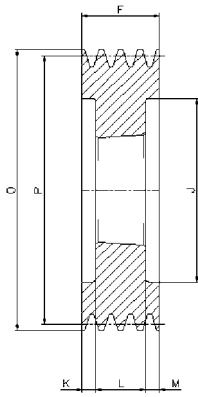

3

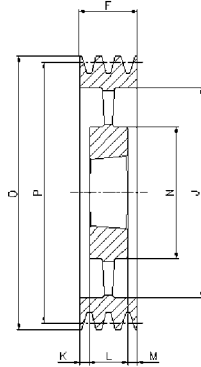

5

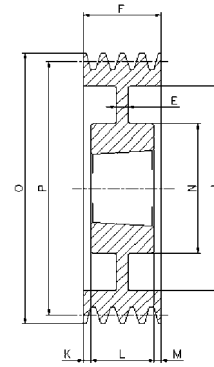

6

SPB/10

Cod. interno Internal code Innerer Code Code interne Código interno	Tipo Type Typ Type Tipo	Gole Grooves Rillen Gorges Canales	P	O	Forma Form Forme Forme Forma	Bussola Bush Buchse Moyeu Casquillo	∅ MAX	E	F	J	K	L	M	N
BT0224X	SPB224-10	10	224	231	3	3535	90	-	196	181	53,5	89	53,5	-
BT0236X	SPB236-10	10	236	243	3	3535	90	-	196	193	53,5	89	53,5	-
BT0250X	SPB250-10	10	250	257	3	3535	90	-	196	207	53,5	89	53,5	-
BT0280X	SPB280-10	10	280	287	6	3535	90	30	196	237	53,5	89	53,5	175
BT0315X	SPB315-10	10	315	322	6	3535	90	30	196	272	53,5	89	53,5	175
BT0335X	SPB335-10	10	335	342	6	4040	100	30	196	292	47,0	102	47,0	210
BT0355X	SPB355-10	10	355	362	6	4040	100	30	196	312	47,0	102	47,0	210
BT0400X	SPB400-10	10	400	407	6	4040	100	30	196	357	47,0	102	47,0	210
BT0450X	SPB450-10	10	450	457	5	4545	110	-	196	407	41,0	114	41,0	242
BT0500X	SPB500-10	10	500	507	5	4545	110	-	196	457	41,0	114	41,0	242
BT0560X	SPB560-10	10	560	567	5	4545	110	-	196	517	41,0	114	41,0	242
BT0630X	SPB630-10	10	630	637	5	4545	110	-	196	587	41,0	114	41,0	242
BT0710X	SPB710-10	10	710	717	5	4545	110	-	196	664	41,0	114	41,0	242
BT0800X	SPB800-10	10	800	807	5	4545	110	-	196	754	41,0	114	41,0	242
BT0900X	SPB900-10	10	900	907	5	5050	125	-	196	854	34,5	127	34,5	267
BT1000X	SPB1000-10	10	1000	1007	5	5050	125	-	196	954	34,5	127	34,5	267